



154BSD

Digital Output

SPECIFICATIONS

- **Stainless steel with O-ring mount**
- **Pressure/temperature read-out**
- **Digital output**
- **ASIC calibrated**
- **Absolute, gage**
- **Cable/connector option**
- **Low power option**
- **19mm diaphragm diameter**

FEATURES

- O-Ring mount
- $\pm 0.25\%$ Accuracy
- ± 1.0 Total Error Band
- Cable/connector option
- Low power option
- I²C or SPI Interface protocols

APPLICATIONS

- Tank level measurement
- Corrosive fluids and gas measurement systems
- Sealed systems
- Manifold pressure measurement
- Barometric pressure measurement
- Submersible depth monitoring
- Medical instruments

The 154BSD is a small profile, media compatible, piezoresistive silicon pressure sensor packaged in a 316L stainless steel housing. This 14-bit digital output pressure sensor supports I²C and SPI interface protocols with a 3.3 or 5.0V_{DC} supply voltage and is designed for O-ring mounting. The sensing package utilizes silicone oil to transfer pressure from the 316L stainless steel diaphragm to the sensing element.

The 154BSD is designed for high performance, low pressure applications. A custom ASIC is used for temperature compensation, offset correction, and provides a digital output of 10~90% or 5~95%.

For a similar sensor with stainless steel fittings, refer to the 85BSD digital output pressure sensor.

STANDARD RANGES

Range	psiG	psiA	Range	barG	barA
0 to 001	•		0 to .07	•	
0 to 002	•				
0 to 005	•		0 to .35	•	
0 to 015	•	•	0 to 001	•	•
0 to 030	•	•	0 to 002	•	•
0 to 050	•	•	0 to 005	•	•
0 to 100	•	•	0 to 007	•	•
0 to 150	•	•	0 to 010	•	•
0 to 200	•	•	0 to 014	•	•
0 to 300	•	•	0 to 020	•	•

PERFORMANCE SPECIFICATIONS

Unless otherwise specified: Supply Voltage: 3.3V_{DC}, Ambient Temperature: 25°C

PARAMETERS	MIN	TYP	MAX	UNITS	NOTES
Zero Pressure Output (10% ~ 90%)		666		Count Hex	1
Zero Pressure Output (5% ~ 95%)		333		Count Hex	1
Full Scale Pressure Output (10% ~ 90%)		399A		Count Hex	1
Full Scale Pressure Output (5% ~ 95%)		3CCB		Count Hex	1
Accuracy	-0.25		0.25	%Span	2
Total Error Band	-1		1	%Span	3
Pressure Resolution	0.008			%Span	
Temperature Accuracy	-1.5		1.5	°C	4
Resolution – Temperature		0.1		°C	
Input Voltage Range	2.7	3.3	5.5	V	1
Supply Current		3		mA	
Insulation Resistance (50Vdc)	50			MΩ	5
Overpressure			2X	Rated	6
Burst Pressure			3X	Rated	7
Load Resistance (R _L)	10			KΩ	
Long Term Stability (Offset & Span)		±0.5		%Span/Year	
Compensated Temperature (≤5psi)	0		50	°C	
Compensated Temperature (≥15psi)	-20		+85	°C	
Operating Temperature	-40		+125	°C	8
Storage Temperature	-40		+125	°C	8
Output Pressure Resolution			14	Bits	
Output Temperature Resolution	8		11	Bits	
Start Time to Data Ready			8.4	ms	9
Output Type	10% to 90% or 5% to 95%				
Interface Type	I ² C (ADDR, 0x28H)				
	I ² C (ADDR, 0X36H)				
	I ² C (ADDR, 0x46H)				
	SPI				
Media – Pressure	Liquids and gases compatible with 316/316L Stainless Steel and Buna-N Rubber				

Notes

1. Measured at vacuum for absolute(A), ambient for gage(G). Output is not ratiometric to supply voltage.
2. Accuracy: combined linearity, hysteresis and repeatability.
3. Total Error Band: includes calibration errors and temperature effects over the compensated range. See Figure 3.
4. The deviation from a best fit straight line (BFSL) fitted to the output measured over the compensated temperature range. See Figure 2.
5. Between case and sensing element.
6. 2X or 400psi, whichever is less. The maximum pressure that can be applied to a transducer without changing the transducer's performance or accuracy.
7. 3X or 600psi, whichever is less. The maximum pressure that can be applied to a transducer without rupture of either the sensing element or transducer.
8. Maximum temperature range for product with standard cable and connector is -20°C to +105°C.
9. Start time to data ready is the time to get valid data after POR (Power on Reset). The time to get subsequent valid data is then specified by the response time specification.
10. Device Marking:
Each part shall be identified with Model Number, Pressure Range, Type, Lot Number, Serial Number and Date Code.
11. Shipping/Packaging:
Each unit will be packaged individually in a plastic vial with anti-static foam. The stainless steel diaphragm is protected by a static dissipative cap.

12. Direct mechanical contact with diaphragm is prohibited. Diaphragm surface must remain free of defects (scratches, punctures, dents, fingerprints, etc) for device to operate properly. Caution is advised when handling parts with exposed diaphragms. Use protective cap whenever devices are not in use.

DIMENSIONS [mm]

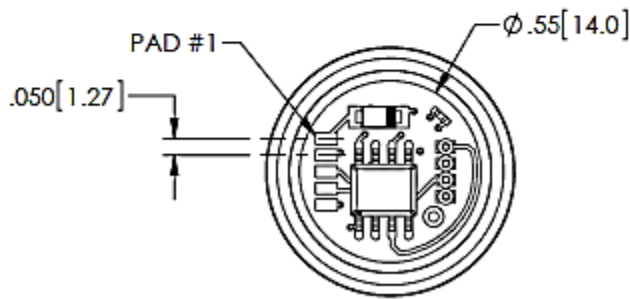
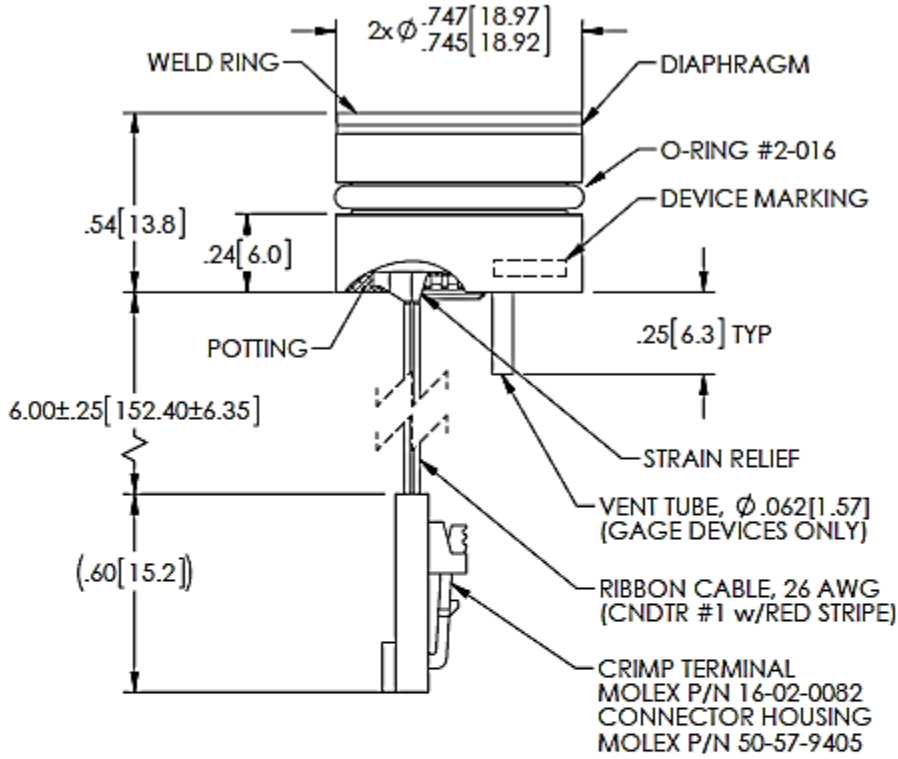

PAD/CNDR	FUNCTION
1	VDD
2	GND
3	SCL/SCLK
4	SDA/MISO
5	INT/SS

VIEW SHOWN w/o POTTING, CABLE AND CONNECTOR FOR CLARITY

BLOCK DIAGRAM

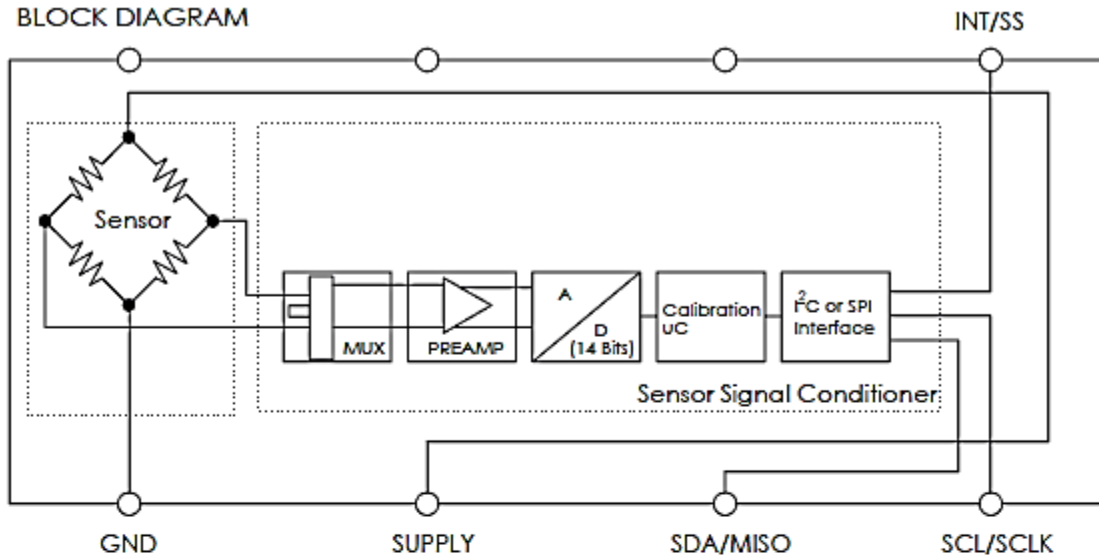

Fig 1

I2C INTERFACE PARAMETERS

PARAMETERS	SYMBOL	MIN	TYP	MAX	UNITS
SCLK CLOCK FREQUENCY	F _{SCL}	100		400	KHz
START CONDITION HOLD TIME RELATIVE TO SCL EDGE	t _{HDSTA}	0.1			us
MINIMUM SCL CLOCK LOW WIDTH @1	t _{LOW}	0.6			us
MINIMUM SCL CLOCK HIGH WIDTH @1	t _{HIGH}	0.6			us
START CONDITION SETUP TIME RELATIVE TO SCL EDGE	t _{SUSTA}	0.1			us
DATA HOLD TIME ON SDA RELATIVE TO SCL EDGE	t _{HDDAT}	0			us
DATA SETUP TIME ON SDA RELATIVE TO SCL EDGE	t _{SUDAT}	0.1			us
STOP CONDITION SETUP TIME ON SCL	t _{SUSTO}	0.1			us
BUS FREE TIME BETWEEN STOP AND START CONDITION	t _{BUS}	2			us

SPI INTERFACE PARAMETERS

PARAMETERS	SYMBOL	MIN	TYP	MAX	UNITS
SCLK CLOCK FREQUENCY	F _{SCL}	50		800	KHz
SS DROP TO FIRST CLOCK EDGE	t _{HDSS}	2.5			uS
MINIMUM SCL CLOCK LOW WIDTH @1	t _{LOW}	0.6			uS
MINIMUM SCL CLOCK HIGH WIDTH @1	t _{HIGH}	0.6			uS
CLOCK EDGE TO DATA TRANSITION	t _{CLKD}	0		0.1	uS
RISE OF SS RELATIVE TO LAST CLOCK EDGE	t _{SUSS}	0.1			uS
BUS FREE TIME BETWEEN RISE AND FALL OF SS	t _{BUS}	2			uS

@1 COMBINED LOW AND HIGH WIDTHS MUST EQUAL OR EXCEED MINIMUM SCL PERIOD.

TEMPERATURE/PRESSURE ACCURACY

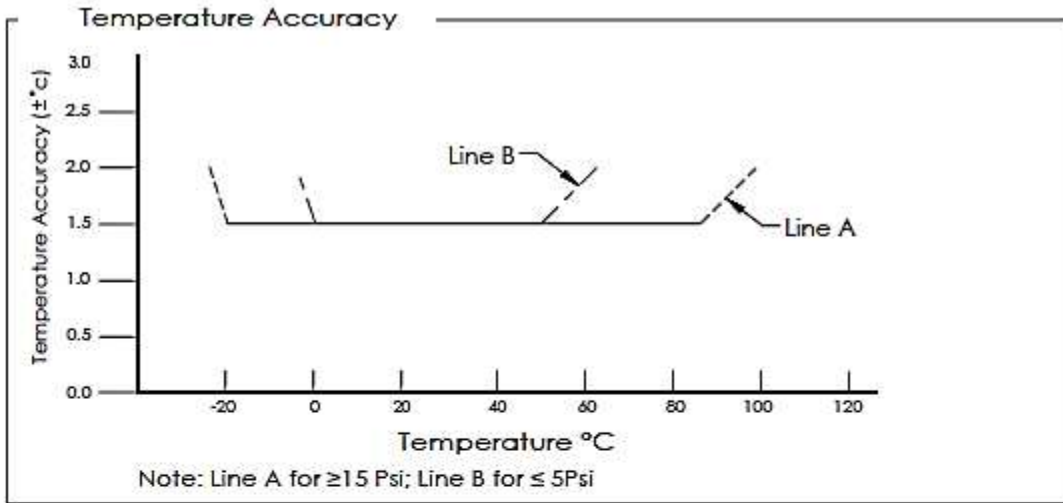

Fig 2

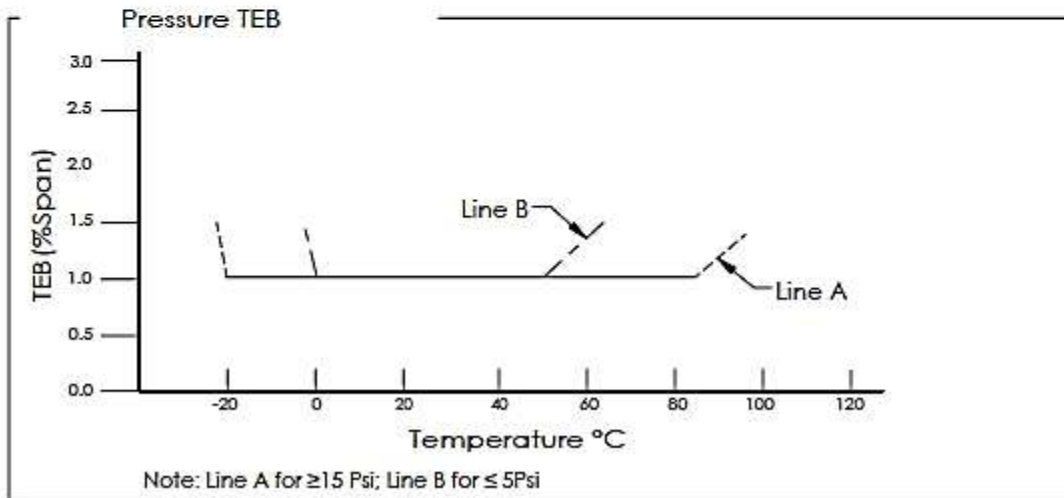

Fig 3

PRESSURE TRANSFER FUNCTIONS

Pressure Transfer Functions

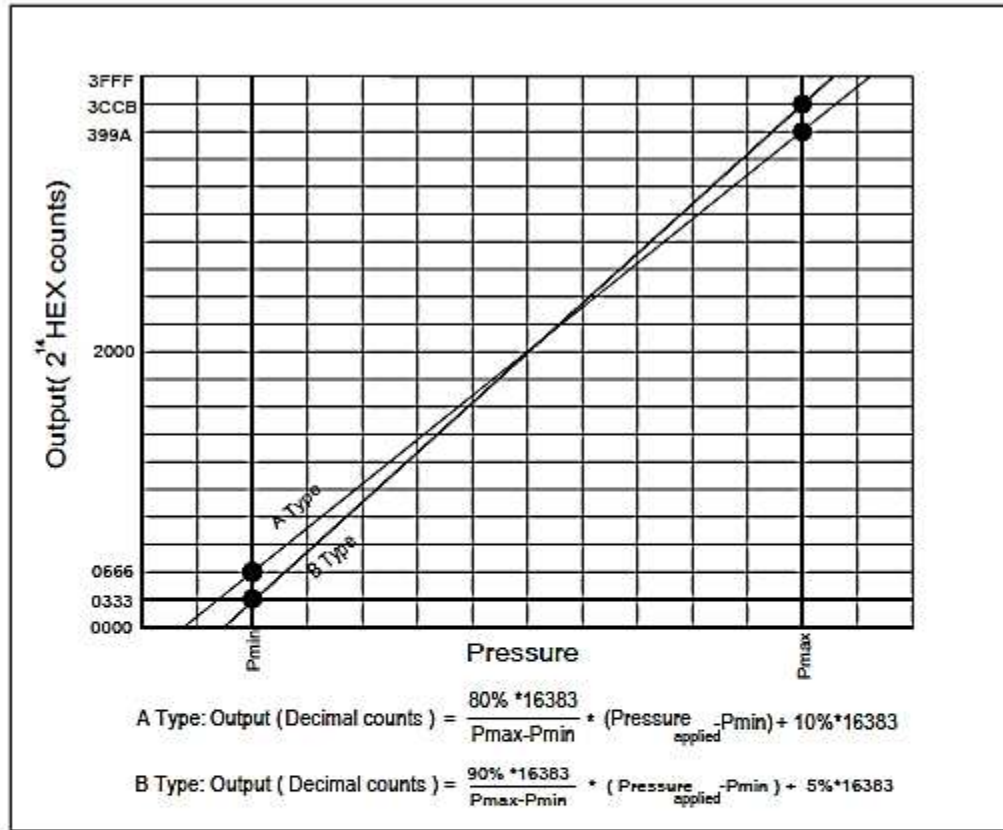

Fig 4

Sensor Output at Significant Percentages

% Output	Digital Counts (decimal)	Digital Counts (hex)
0	0	0 X 0000
5	819	0 X 0333
10	1638	0 X 0666
50	8192	0 X 2000
90	14746	0 X 399A
95	15563	0 X 3CCB
100	16383	0 X 3FFF

TEMPERATURE TRANSFER FUNCTIONS

Temperature Transfer Functions

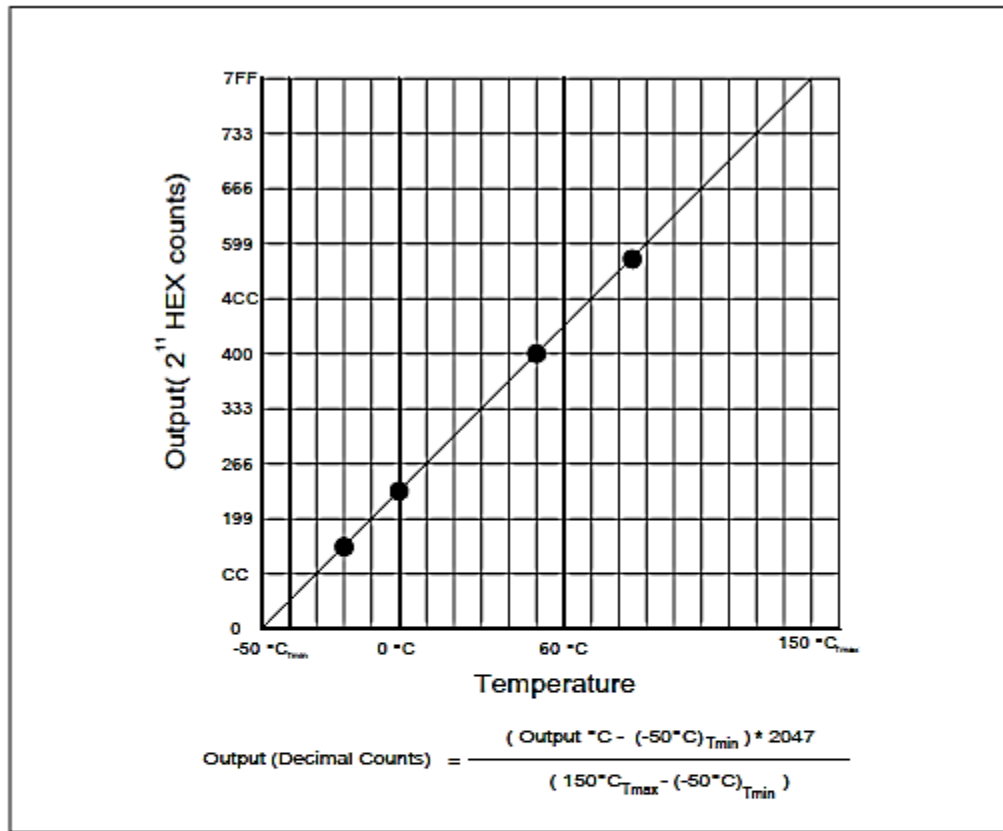

Fig 5

Temperature Output vs Counts

Output °C	Digital Counts (decimal)	Digital Counts (hex)
-50	0	0 X 0000
-20	307	0 X 0133
0	512	0 X 0200
25	767	0 X 02FF
50	1024	0X 0400
85	1381	0 X 0565
150	2047	0 X 07FF

ORDERING INFORMATION

154BSD 030P A - 3 B J R (LT)

Pressure Range		
psi	bar	
001P	.07B	Gage Only
002P	-	
005P	.35B	
015P	001B	Absolute and Gage
050P	002B	
100P	007B	
150P	010B	
200P	014B	
300P	020B	

Intermediate pressure ranges available

Pressure Type	
G	Gage
A	Absolute

Supply Voltage	
3	3.3V _{DC}
5	5.0V _{DC}

Power Mode/Vent Tube	
[Blank]	Standard w/o Tube
L	Low Power w/o Tube
T	Standard w/ Tube
LT	Low Power w/ Tube

Connection	
P	Pad
R	Ribbon cable
C	Cable w/ Connector

Interface	
I	I ² C (Addr. 0x28H)
J	I ² C (Addr. 0x36H)
K	I ² C (Addr. 0x46H)
S	SPI

Output	
Code	Output
A	10 – 90%
B	5 – 95%